

CODICE	DESCRIZIONE
AL12004	Alimentatore ON/OFF tensione costante 12Vdc 4W Cavi IN/OUT, IP65 Vin 220-240Vac Dimensioni mm 38x28x21H

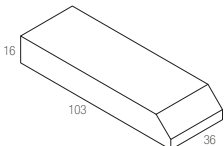

CODICE	DESCRIZIONE
AL12015	Alimentatore ON/OFF tensione costante 12Vdc 15W Morsetti a vite protetti, IP20 Vin 220-240Vac Dimensioni mm 103x36x16H



CODICE	DESCRIZIONE
AL12020	Alimentatore ON/OFF tensione costante 12Vdc 20W Morsetti a pressione protetti, IP20 Vin 220-240Vac Dimensioni mm 103x36x16H

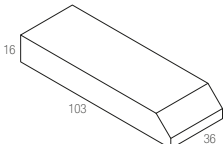

CODICE	DESCRIZIONE
AL12030B	Alimentatore ON/OFF tensione costante 12Vdc 30W Morsetti a pressione protetti, IP20 Vin 220-240Vac Dimensioni mm 155x53x16H

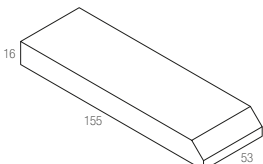

CODICE	DESCRIZIONE
AL12035IP	Alimentatore ON/OFF tensione costante 12Vdc 36W Cavi IN/OUT, IP67 Vin 110-240Vac Dimensioni mm 150x40x30H

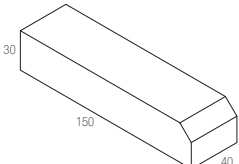

CODICE	DESCRIZIONE
AL12050	Alimentatore ON/OFF tensione costante 12Vdc 50W Morsetti a vite protetti, IP20 Vin 110-240Vac Dimensioni mm 185x64x22H

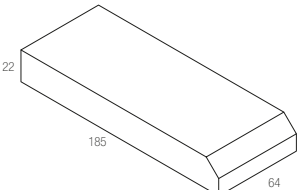

CODICE	DESCRIZIONE
AL12075	Alimentatore ON/OFF tensione costante 12Vdc 75W Morsetti a vite protetti, IP20 Vin 220-240Vac Dimensioni mm 184x61x32H

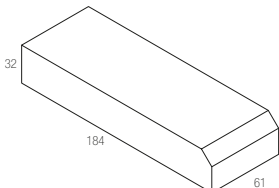

CODICE	DESCRIZIONE
AL12100	Alimentatore ON/OFF tensione costante 12Vdc 100W Morsetti a vite protetti, IP20 Vin 110-240Vac Dimensioni mm 184x61x32H

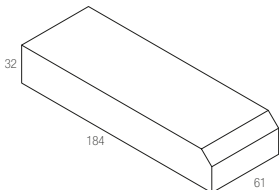

CODICE	DESCRIZIONE
AL12100IP	Alimentatore ON/OFF tensione costante 12Vdc 100W Cavi IN/OUT, IP67 Vin 110-240Vac Dimensioni mm 190x52x37H

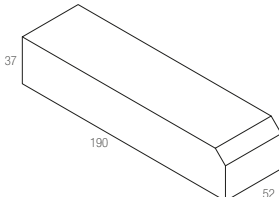

CODICE	DESCRIZIONE
AL12150	Alimentatore ON/OFF tensione costante 12Vdc 150W Morsetti a vite protetti, IP20 Vin 220-240Vac Dimensioni mm 210x67x34H

